

# Programmable two-dimensional actuation of ferrofluid droplet using planar microcoils

Beyzavi, Ali; Nguyen, Nam-Trung

2010

Beyzavi, A. & Nguyen, N. T. (2010). Programmable two-dimensional actuation of ferrofluid droplet using planar microcoils. *Journal of Micromechanics and Microengineering*, 20(1).

<https://hdl.handle.net/10356/94546>

<https://doi.org/10.1088/0960-1317/20/1/015018>

---

© 2010 IOP Publishing Ltd. This is the author created version of a work that has been peer reviewed and accepted for publication by *Journal of Micromechanics and Microengineering*, IOP Publishing Ltd.. It incorporates referee's comments but changes resulting from the publishing process, such as copyediting, structural formatting, may not be reflected in this document. The published version is available at: [DOI:<http://dx.doi.org/10.1088/0960-1317/20/1/015018>].

*Downloaded on 21 Jul 2024 21:21:00 SGT*

This document is downloaded from DR-NTU, Nanyang Technological University Library, Singapore.

Title	Programmable two-dimensional actuation of ferrofluid droplet using planar microcoils
Author(s)	A. Beyzavi, N.T. Nguyen
Citation	
Date	2010
URL	<a href="http://hdl.handle.net/null">http://hdl.handle.net/null</a>
Rights	

# Programmable two-dimensional actuation of ferrofluid droplet using planar microcoils

Ali Beyzavi, Nam-Trung Nguyen §

† School of Mechanical and Aerospace Engineering, Nanyang Technological University, 50 Nanyang Avenue, Singapore 639798

## Abstract.

This paper reports the concept and the device for two-dimensional magnetic actuation of a ferrofluid droplet. Four planar microcoils were etched on one side of a printed circuit board (PCB). The magnetic field was digitally controlled by adjusting the magnitude and the polarity of the driving current in the coils. A computer programme generates the control signals, which are conditioned by an external amplifier circuit and transferred to the coils. The ferrofluid droplet is attracted to the field maximum. With the controlled magnetic field, the location of the field maximum can be changed electronically allowing the droplet to move in a closed loop on the planar platform. The concept presented in this paper can have a variety of applications in digital microfluidics such as sample transport or mixing.

§ To whom correspondence should be addressed (mntnguyen@ntu.edu.sg)

## 1. Introduction

Recently, droplet-based microfluidic systems are capable of performing a variety of tasks required in chemical, biological and biomedical analysis. These systems carry out a number of protocols that can be programmed and reconfigured [1]. These droplet-based microfluidic devices benefit from the shorter diffusion path and from the cost reduction due to the smaller amount of sample and reagent required. Since the early development of microfluidics, manipulating fluids in small quantities is one of the important tasks for micro total analysis systems [2, 3]. In conventional continuous-flow microfluidics, liquids are contained within microchannels, and manipulated by micropumps and microvalves to carry out the required tasks. Microfluidic components such as micromixers, micropumps and microvalves need sophisticated microfabrication technologies [4] leading to the high cost of development and fabrication. Droplet-based microfluidics could offer better solutions for the same applications. Besides the smaller sample size as mentioned above, the manipulation of discrete droplets would not need a complex microchannel network and active components such as micropumps. Droplets can be controlled and manipulated digitally on a planar surface. A wide range of actuation schemes is available for manipulating droplets such as electrostatics [5], surface acoustic waves [6, 7], thermocapillarity [8] and magnetism [9].

The benefit of using magnetic field for actuation is that the magnetic effect is generally not affected by surface charges, pH level, ionic concentration or temperature [9]. For applications in life sciences, the interaction between the biological samples and the actuation force is a major problem [10], especially if thermocapillarity or electrostatic effect are used. High temperature or strong electric field could destroy biological samples. Magnetic actuation is a good alternative in this case as it has minimum interaction with the samples.

In the past, a number of studies reported the use of permanent magnets for magnetic actuation [11, 12, 13]. Permanent magnets provide a strong magnetic field, but its magnitude and polarity are not controllable. Furthermore, the integration of small permanent magnets into a microfluidic device and its associated cost pose technological and economical challenges. In contrast to a permanent magnet, microcoils working as miniaturized electromagnets seem to be a more suitable option for droplet-based digital microfluidics. The magnitude and polarity of the magnetic field generated by microcoils can be electronically controlled. The characteristics of the magnetic field are well predictable either by numerical [14] or analytical models [15]. A number of research groups have used microcoils for manipulation of magnetic particles. Lee et al. used a microelectromagnet matrix and a ring trap to position and control magnetic micro/nanoparticles [16]. Ahn et al. utilized integrated inductive components for separation of magnetic microbeads [17]. Melikhov et al. used numerical simulation to analyze their motion of a ferrofluid plug in a capillary [18]. Ramadan et al. discussed the use of the magnetic field from current carrying wires for manipulating magnetic particles [19]. Lehmann et al. manipulated magnetic beads suspended in a droplet

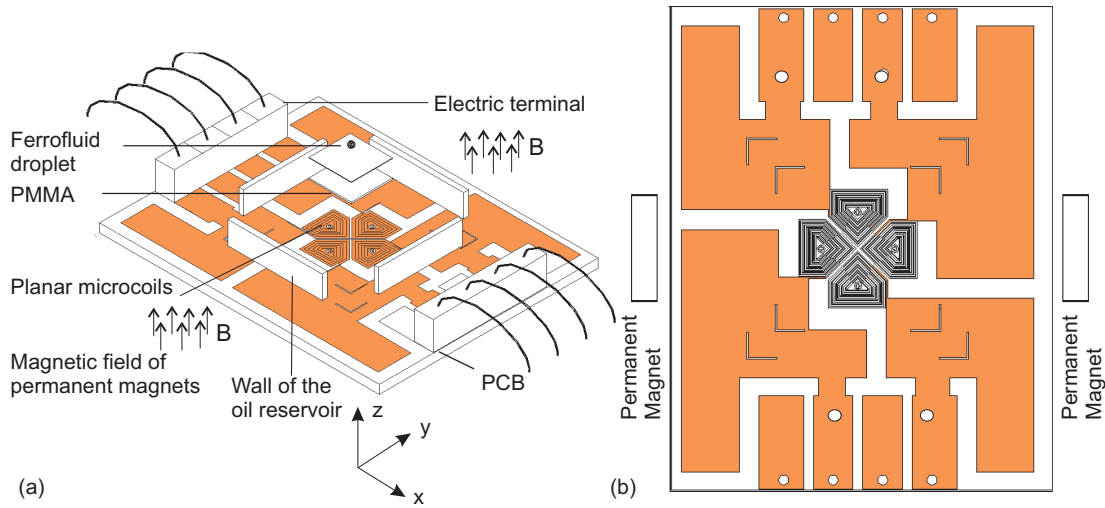
using planar microcoils [10]. Lee et al. fabricated a CMOS-compatible integrated array of coils for manipulating cells tagged with magnetic beads [20]. Rida et al. transported magnetic beads in a glass capillary over a long range using planar coils [21].

In the past, Magnetic microbeads suspended in a droplet have been used for magnetic actuation [10]. Nguyen et al. explored the use of ferrofluids for this purpose [22]. Ferrofluid is a class of nanofluids with suspending magnetic nanoparticles. Magnetic beads usually have a diameter in the range of 250 nm to 6  $\mu\text{m}$ , while ferrofluids have particle size on the order of a few to several tens nanometers. The relatively larger dimension of magnetic beads is a disadvantage, as it can cause redistribution of beads in a droplet. In the worst-case scenario, the droplet can be split into two parts, one with and the other without magnetic beads [10]. The one without the beads can no longer be manipulated by magnetic force. In a ferrofluid droplet, the magnetic particles have smaller size, thus the random motion of the particles overcomes the magnetic force and the distribution of the particles in the droplet is not affected by the applied magnetic field. Therefore, ferrofluid seems to be more suitable for magnetic actuation in droplet-based microfluidics. Recently, Nguyen et al. demonstrated one-dimensional actuation of a ferrofluid droplet using a switching circuit [22, 23]. Beyzavi et al. provided a model describing this one-dimensional actuation scheme [24]. Recently, ferrofluid plug [25] and droplet containing magnetic beads [26] have been used for driving deoxyribonucleic acid (DNA) samples on a two-dimensional platform for polymerase chain reaction (PCR). These platforms require an external permanent magnet driven by a motor. Integrated coils with corresponding control could replace the bulky external driving system of these platforms.

This paper reports the concept and the implementation of programmable two-dimensional (2D) actuation of a ferrofluid droplet in a closed loop. The control signals come from a personal computer with a multi-function card providing digital to analog (D/A) conversion and digital input and output (I/O). The signals are conditioned by an external amplifier and switching circuit before being fed to the driving coils. Four planar microcoils were fabricated on a printed circuit board (PCB). These coils were used to manipulate a ferrofluid droplet immersed in a well containing silicone oil.

## 2. Actuation mechanism and control scheme

Figure 1(a) shows the PCB-based device and its components in details. Four microcoils are etched on top of a double-sided PCB. The wires connecting the coil centers to the electrical terminals were etched on the backside of the PCB. The masks for the microcoils and the connecting wires on the back were printed on a polymer transparency at a resolution of 8000 dpi. This soft mask is often used for prototyping microfluidic devices based on soft lithography. The printed circuit board was purchased off-the-shelf with a prefabricated dry photoresist. After the exposure of both sides of the PCB and the development of the photoresist, the coils and wires were etched out of the copper layers using a ferric chloride ( $\text{FeCl}_3$ ) solution. Fig. 1(b) shows the front layout of the fabricated

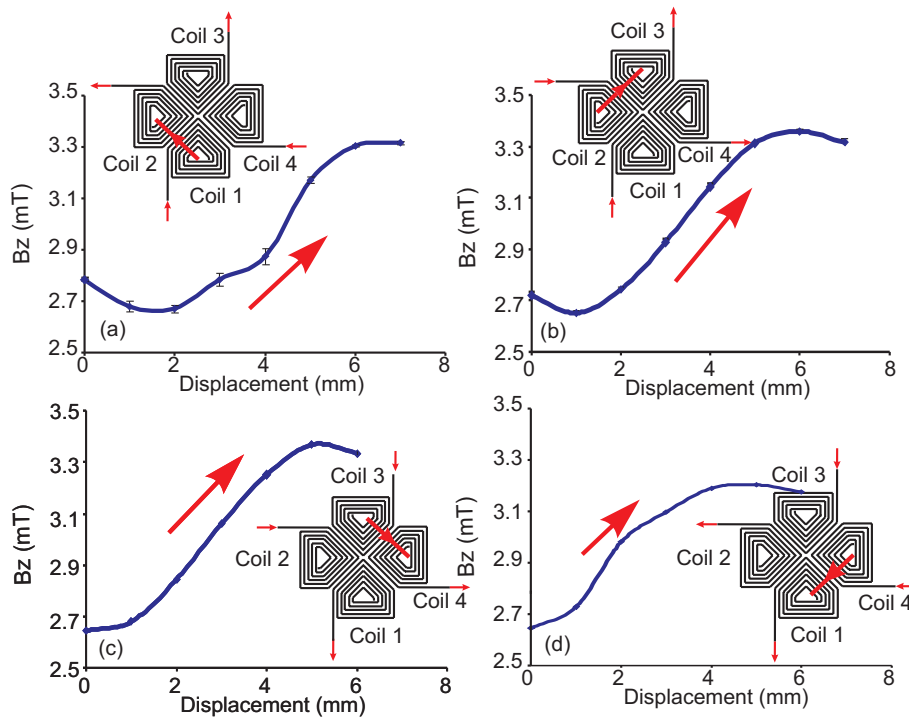


**Figure 1.** The device with four integrated microcoils for two-dimensional actuation of a ferrofluid droplet: (a) Schematic concept; (b) PCB design.

PCB device with the microcoils and corresponding electric terminals. The width of the copper line of the coils was  $100 \mu\text{m}$ . Each coil was designed with 11 windings. The distance between the centers of two neighboring coils is  $6 \text{ mm}$ . The final copper wires of the coils have a cross section of approximately  $40 \times 100 \mu\text{m}$ .

To contain the ferrofluid droplet and its surrounding liquid, a reservoir was constructed around the coils. The reservoir was made out of four poly(methyl methacrylate) (PMMA) pieces glued together by adhesives. The reservoir was filled with silicone oil (Sigma Aldrich,  $[\text{Si}(\text{CH}_3)_2\text{O}]_n$ ,  $\rho = 960 \text{ kg/m}^3$ ,  $\nu = 50 \text{ cSt}$ ). Silicone oil plays two roles in our application. First, the ferrofluid droplet can be suspended in the oil and maintains a spherical shape due to the interfacial tension between the two fluids. Second, the current passing through the coil not only generates a magnetic field but also heat. Since all the coils are in touch with the oil, the heat generated can be absorbed and dissipated. Thus, the coils are protected from burning and other temperature-related effects in later experiments can be minimized. A  $100\text{-}\mu\text{m}$  thin Teflon sheet was placed over the coils to reduce friction and wetting. Two permanent magnets (NdFeB) were placed on the sides of the PCB to polarize the magnetic particles and to add an offset to the local magnetic field generated by the coils. With this setup, a ferrofluid droplet suspended in silicone oil can be moved by magnetic force in the area confined between the centers of the coils.

In a magnetic field, magnetic particles are attracted to the local maximum. The coils can generate a local magnetic field that is controlled by an amplifier circuit and a PC. The location of the local field peak can be positioned on the two-dimensional platform in a controlled manner. Since the ferrofluid droplet follows this peak, it can be manipulated in a 2D trajectory on the planar platform. In order to move the droplet in a loop, coils are activated in a sequence. In each sequence, only one peak exists between two adjacent coils in the actuation path. Figure 2 shows the measured field



**Figure 2.** The measured magnetic flux normal to the coil plane and between the coil centers in the presence of permanent magnets. The uniform magnetic flux of approximately 3 mT in  $z$  direction contributed by the permanent magnets is included. The resultant field has only one peak between two adjacent coils on the actuation path. The ferrofluid droplet is attracted to this peak. The line connecting the coil centers shows the path along which the magnetic flux was measured: (a) Between coil 1 and coil 2; (b) Between coil 2 and coil 3; (c) Between coil 3 and coil 4; (d) Between coil 4 and coil 1.

of each coil pair along the closed loop. The relative displacement is counted from the centre of the first coil of the pair. The measured values include the offsetting magnetic field of the permanent magnets. The measurements were carried out with a commercial gauss meter (GM05, Hirst magnetic instrument, UK). Figure 2 shows the one absolute peak of the magnetic flux between the two neighboring coils. This peak will attract the ferrofluid droplet during the actuation process. Since this local maximum is shifted from one coil to the other in a loop, the droplet can follow the peak in a closed trajectory. If the actuation sequence is repeated for several cycles, the droplet can make several loops. Reversing the direction of the current in the coils can change the direction of the trajectory.

The control scheme was implemented on a personal computer (PC) as shown in Figure 3(a). To generate the control signals, a program was written in MATLAB (MathWorks Inc, USA). This program accesses the multi-function card (Advantech, PCI-1710) with D/A conversion and digital I/O capabilities through the data acquisition toolbox of MATLAB. Both analog and digital outputs can be controlled with this program. Since the card outputs are voltage signals with low current, they should

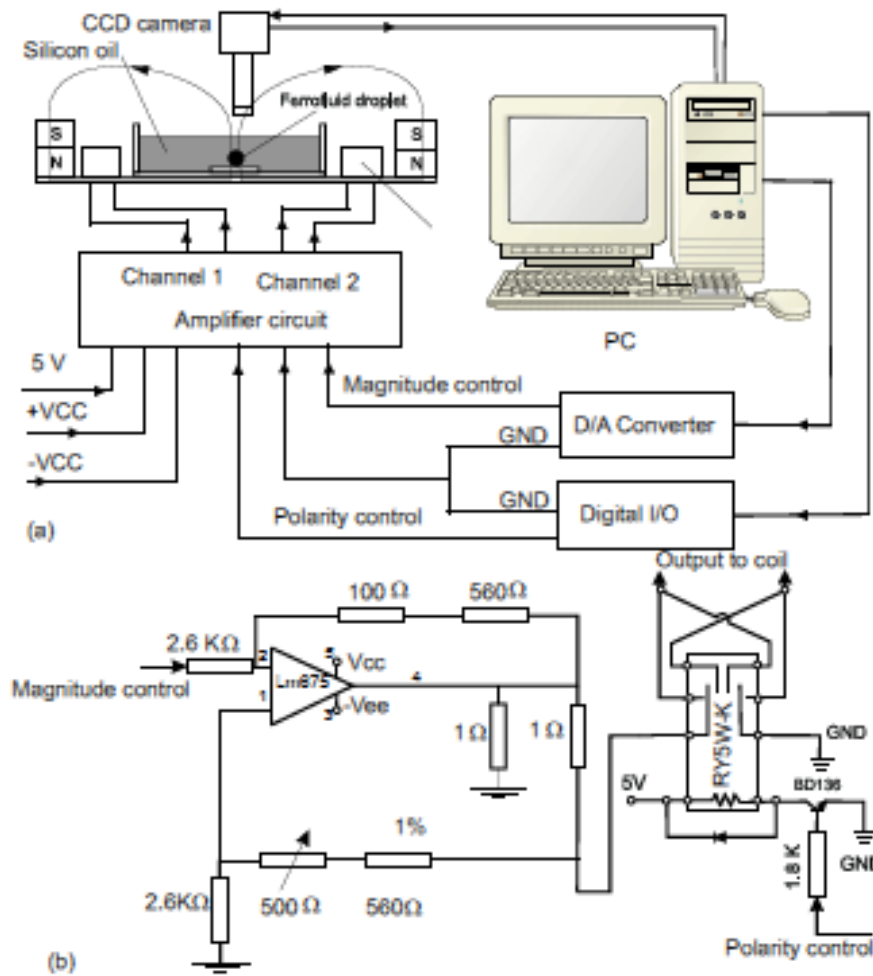
be converted to current signals using a voltage-to-current amplifier circuit. Figure 3(b) shows the circuit used in our work. The voltage to current conversion is based on a power operational amplifier (OPAMP) (LM675, National Semiconductor, USA). Each input channel of the amplifier circuit has two signals: the magnitude control and the polarity control. The analog control from the D/A converter is used for adjusting the magnitude of the driving current in the coils. This input signal ranges from 0 to 5 volts. The corresponding current output can vary from 0 to 2 Amperes. At a typical driving current of 0.5 A, the current density in the coil is approximately 125 A/mm<sup>2</sup>. The voltage to current conversion can be calibrated using the 500-Ohm potentiometer depicted in Fig. 3(b). The polarity control signal from the digital input/output (IO) was used for switching the direction of the driving current. This polarity control signal is buffered by transistor and fed to an electromagnetic relay (RY5W-K, Fujitsu, Japan). When the relay is activated, the direction of the current in the coil connected to the relay is inverted. The heat generated in the power OPAMP and shunt resistors cause fluctuations in the current output. To minimize this problem, the OPAMPs are connected to a heat sink. Two fans were mounted over the circuit box for forced cooling.

Figure 4(a) shows the control sequences and the configuration of the actuating coils to move the ferrofluid droplet in a loop. The circuit was designed with four output channels for the possible control of the four individual coils. However, in the experiments reported in this paper only two channels were used. The opposite coils were connected in serial as a pair by linking their centers. With this scheme only two output channels are needed. Furthermore, the discrepancy in magnitude of the driving currents in different coils can be minimized. At any given time, the current passing two neighboring coils always have opposite signs. Thus, with the magnetic field generated, a droplet can move from the center of one coil to the center of another coil as illustrated in Figure 4(b).

### 3. Experimental setup and results

Figure 3(a) shows the experimental setup used for actuating and recording the motion of the droplet. The motion was recorded by a CCD camera with a resolution of  $640 \times 480$  pixels. The camera can be triggered by the same control circuit and thus synchronized with the droplet motion. The frame rate of the camera is adjusted according to the velocity of the droplet. The time lapse between two image frames is known and can be used for calculating the velocity and acceleration of the droplet. After capturing and recording, the images were processed by a MATLAB program using the image processing tool box. Each image frame was first converted into a binary image to identify the ferrofluid droplet. The position of the centroid of the droplet was subsequently detected in every frame. The trajectories of the motion were obtained by following the centroid positions over the recorded frames. The displacement and the corresponding velocity as functions of time were subsequently calculated from the positions and the known time lapse between two frames. The ferrofluid APG S10n

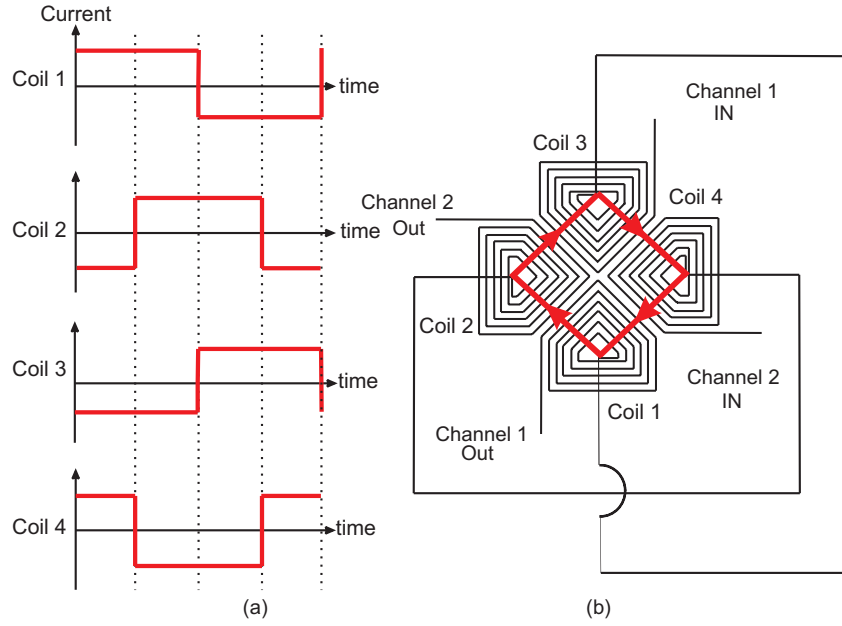




**Figure 3.** (a) Experimental setup for 2D actuation platform; (b) control circuit for the magnitude and polarity of the driving currents.

(Ferrotec, <http://www.ferrotec.com>, USA) was used in our experiments. The carrier liquid of this ferrofluid is synthetic ester oil. The viscosity and the density of the ferrofluid at 25°C are  $\eta_{ff} = 0.406 \text{ kg/ms}$  and  $\rho_{ff} = 1,330 \text{ kg/m}^3$ , respectively. The surface tension of the fluid is  $\sigma_{ff} = 32 \times 10^3 \text{ N/m}$ . The ferrofluid has a saturation magnetization of 44 mT and an initial susceptibility of  $\chi = 1.6$ . For all experiments, ferrofluid droplet with a diameter of approximately 1 mm was dispensed manually on the platform using a syringe with attached needle. Due to the relatively slow motion of the droplet and the limited image buffer, the images were recorded at a rate of one frame per second.

To verify the actuation concept, the motion between two neighboring coils were first characterized. Figures 5(a) and (b) show the trajectory of the droplet motion between two adjacent coil centers in one cycle and over several cycles, respectively. Since the coil design is not symmetric and the other coils on the platform are also activated, the trajectory is curved toward the center of the platform. The driving schemes and the corresponding coil pairs are shown in Figs. 5(c) and (d), respectively. The droplet can reverse its direction with the change in polarity of the driving current. Since the analog

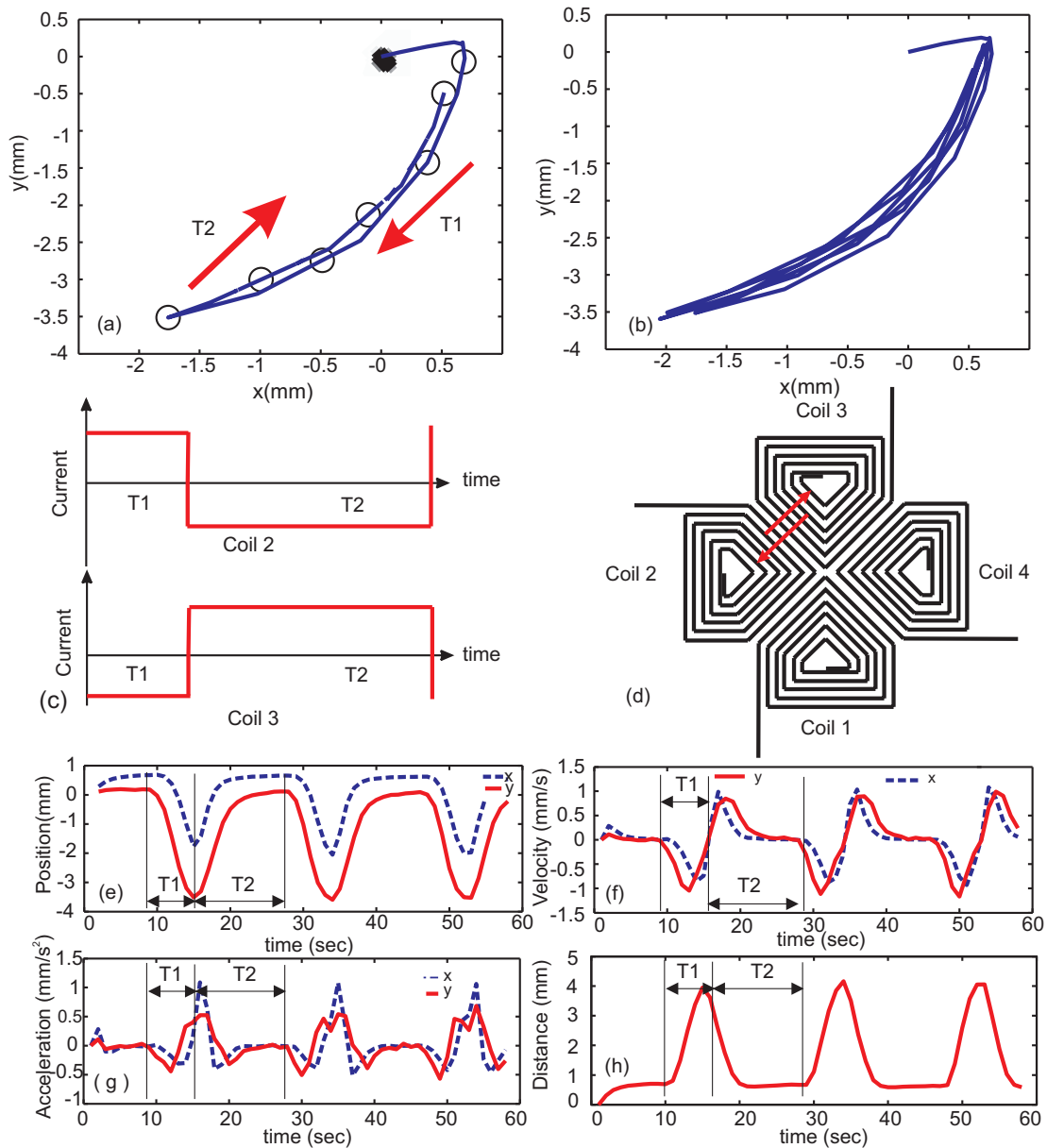


**Figure 4.** Two-dimensional actuation: (a) Sequences of driving currents of the four micro coils for driving a ferrofluid droplet in a loop. (b) Arrangement of the four coils for controlling with two output channels. The red arrows show the direction of the droplet motion between two neighboring coils.

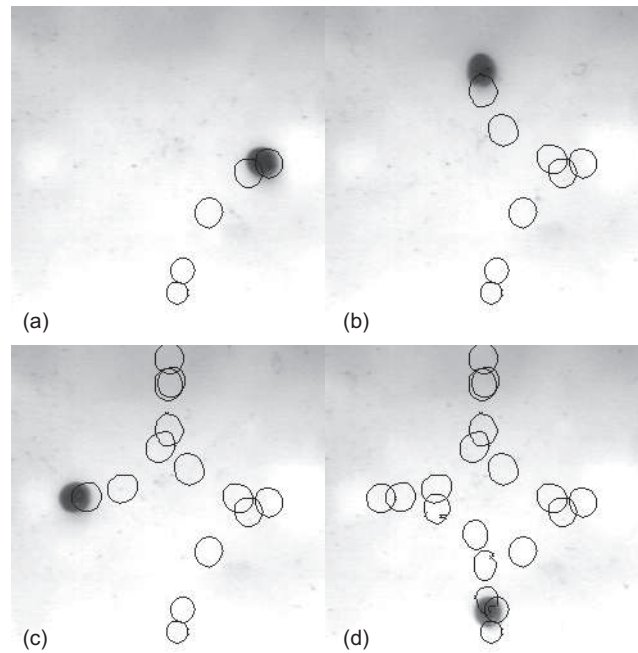
output is unipolar, switching the polarity of the current was achieved with a digital output and an electromagnetic relay as described above.

Figures 5 (e) to (h) show the position, the velocity, acceleration and the relative traveling distance as functions of time evaluated from the recorded images. Figure 5(e) shows the droplet position ( $x, y$ -coordinates) over time. For the convenience of evaluation, the starting point of the droplet is taken as the origin of the coordinate system. To distinguish the direction corresponding to a current polarity, one period was kept longer than the other ( $T_2 = 15$  s,  $T_1 = 5$  s). Thus, the droplet takes longer time for the upward period [Fig. 5(d)] and is trapped at the center of the lower coil 2 before moving back. The corresponding velocity of the droplet is shown in Fig. 5(f). Positive velocity means the upward motion, while negative velocity indicates the downward motion. The results shown in Fig. 5(f) are consistent with our previous data from one-dimensional actuation of a ferrofluid droplet [24]. The acceleration at the start and the deceleration at the end of each period can be seen in Fig. 5(g). Figure 5 (h) shows the relative distance of the droplet from the initial position next to the center of coil 3 [Fig. 5(d)]. This relative distance was evaluated as  $\sqrt{x^2 + y^2}$ , where  $x$  and  $y$  are the positions depicted in Fig. 5(e). When the droplet reaches the center of coil 2, the relative traveling distance has its maximum.

With the successful actuation of the ferrofluid droplet between two neighboring coils, the actuation scheme was extended to a closed loop across all four coils. Figure 6 shows the captured images of the ferrofluid droplet at the four coil centers and its corresponding trajectories. The images in Fig. 6 was realized with a customized



**Figure 5.** One-dimensional actuation: (a) Motion of a ferrofluid droplet between two coil centers in one actuation cycle; (b) The trajectory of the droplet over several cycles; (c) The sequence of the driving currents; (d) The arrangement of the coils; (e) Position of the droplet versus time ( $T1 = 5$  s,  $T2 = 15$  s); (f) Velocity of the droplet versus time; (g) Acceleration of the droplet versus time; (h) The relative distance from the initial position versus time.

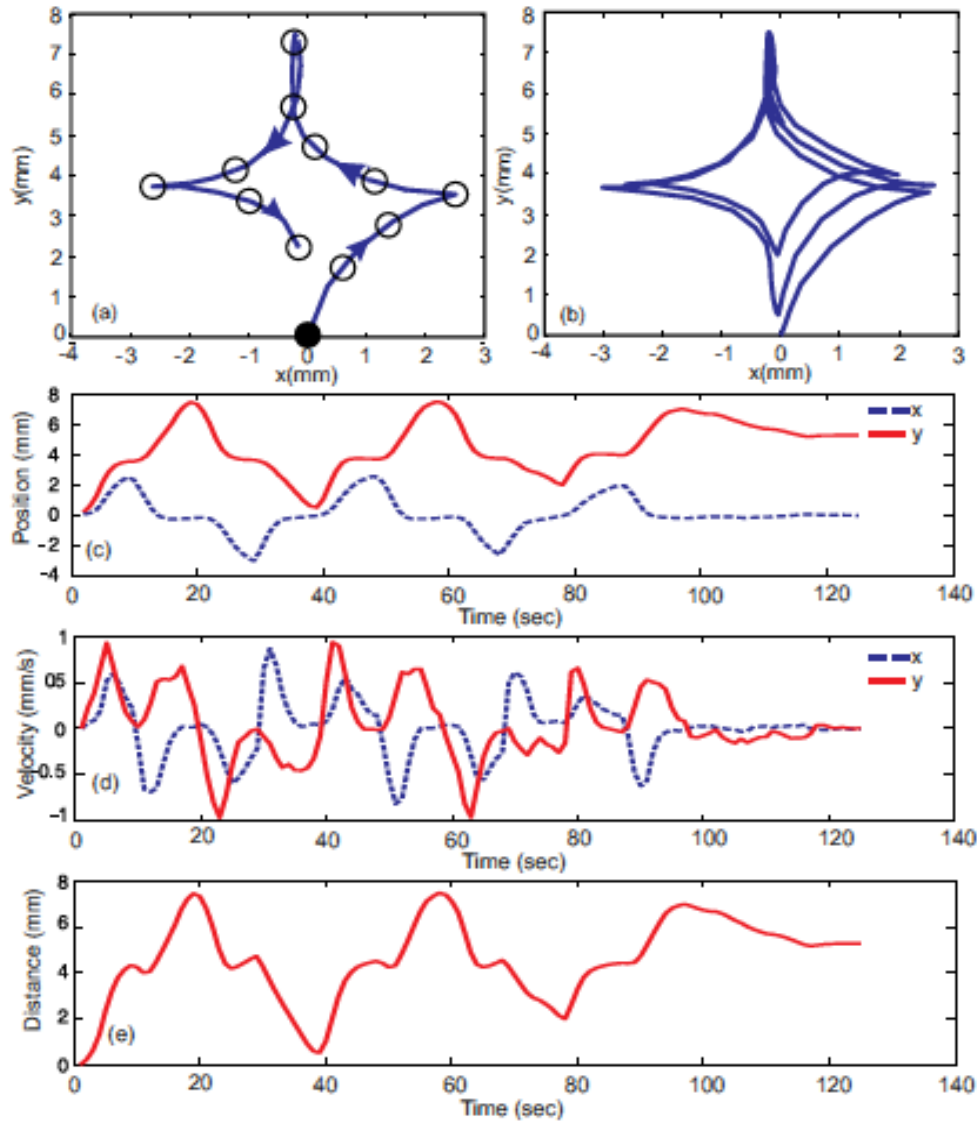


**Figure 6.** Ferrofluid droplet and its trajectory under two-dimensional actuation. The droplet is tracked every 2 seconds.

MATLAB routine, that tracks the droplet, traces and superimposes its outline on the final image frame. Figure 7(a) shows the droplet motion in a full loop between four coil centers. Figure 7(b) depicts the trajectory of several subsequent loops. Since the droplet can not reach its initial position after each loop, the droplet spirals toward the center of the platform. The problem may be caused by the instability of the driving current and by thermocapilarity induced by the heat generated from the coils. This problem can be solved by using a closed-loop control mechanism, where the position of the droplet recorded with the camera is fed back to the control signal to correct the control signal. A real-time control system would require a fast camera and the coupling between the different toolboxes of MATLAB such as image processing, data acquisition and control. Figure 7(c) depicts the position of the droplet as function of time evaluated from the recorded images. Figures 7(d) and (e) show the velocity and the relative distance from the initial position of the droplet, respectively.

#### 4. Conclusions

This paper demonstrates two-dimensional, programmable actuation of a ferrofluid droplet in a closed loop on a planar platform. The actuation concept manipulates the position of the peak of the local magnetic field on the platform. A magnetic object such as the ferrofluid droplet is attracted to the field maximum. If the position of the field maximum is changed, the droplet follows the field peak and therefore can be moved on a desired path. The reported device consists of four planar microcoils fabricated on a PCB using photo lithography and etching. In every time step, two local field maxima



**Figure 7.** Two-dimensional actuation: (a) Motion of a ferrofluid droplet in a loop formed by four coil centers; (b) The trajectory of the droplet over several cycles; (c) Position of the droplet versus time; (d) Velocity of the droplet versus time; (e) The relative distance from the initial position versus time.

were created by combining the local magnetic fields of the neighboring microcoils with the global field of external permanent magnets. The droplet is attracted to the nearest peak of the magnetic field and can be actuated. With the help of a control system consisting of a PC, a multi-function card, an amplifier circuit, this local maximum can be rotated in a closed loop. Consequently, the ferrofluid droplet is dragged along this loop. The device presented in this paper shows the proof of concept for two-dimensional programmable magnetic actuation which finds applications in a variety of lab on a chip platforms. In these applications, the droplet can be loaded with chemical as well as biological samples and works as a container and a reactor.

## Acknowledgement

The authors would like to thank the Agency of Science, Technology and Research, Singapore A\*STAR, SERC Grant No. 0521010108 "Droplet-based micro/nanofluidics" for its financial support. Ali Beyzavi is grateful for the scholarship provided by Nanyang Technological University during his Master of Engineering candidature resulting in the work presented in this paper.

## References

- [1] Teh SY, Lin R, Hung LH and Lee AP 2008 Droplet microfluidics *Lab on a Chip* **8** 198–220
- [2] Reyes DR, Iossifidis D, Auroux, PA and Manz A 2002 Micro Total Analysis Systems. 1. Introduction, Theory, and Technology *Analytical Chemistry, Washington DC* **74** 2623–2636
- [3] Vilkner T, Janasek D, and Manz A 2004 Micro Total Analysis Systems. Recent Developments *Analytical Chemistry, Washington DC* **76** 3373–3386
- [4] Madou MJ 2002 Fundamentals of Microfabrication: The Science of Miniaturization *CRC Press*
- [5] Velev OD and Bhatt KH 2006 On-chip micromanipulation and assembly of colloidal particles by electric fields *Soft Matter* **2** 738–750
- [6] Wixforth A 2003 Acoustically driven planar microfluidics *Superlattices and Microstructures* **33** 389–396
- [7] Wixforth A, Advalytix AG and Brunnthall G 2005 Flat fluidics: acoustically driven planar microfluidic devices for biological and chemical applications *Solid-State Sensors, Actuators and Microsystems, 2005. Digest of Technical Papers. TRANSDUCERS'05. The 13th International Conference on* **1**
- [8] Ting TH, Yap YF, Nguyen NT, Wong TN, Chai JCK and Yobas L 2006 Thermally mediated breakup of drops in microchannels *Applied Physics Letters* **89** 234101
- [9] Pamme N 2006 Magnetism and microfluidics *Lab on a Chip* **6** 24–38
- [10] Lehmann U, Hadjidj S, Parashar VK, Vandevyver C, Rida A and Gijs MAM 2006 Two-dimensional magnetic manipulation of microdroplets on a chip as a platform for bioanalytical applications *Sensors & Actuators: B. Chemical* **117** 457–463
- [11] Guo ZG, Zhou F, Hao JC, Liang YM, Liu WM and Huck WTS 2006 Stick and slide ferrofluidic droplets on superhydrophobic surfaces *Applied Physics Letters* **89** 081911
- [12] Dorvee JR, Derfus AM, Bhatia SN and Sailor MJ 2004 Manipulation of liquid droplets using amphiphilic, magnetic one-dimensional photonic crystal chaperones *Nature Materials* **3** 896–899
- [13] Yamahata C, Chastellain M, Parashar VK, Petri A, Hofmann H and Gijs MAM 2005 Plastic micropump with ferrofluidic actuation *Microelectromechanical Systems, Journal of* **14** 96–102
- [14] Feustel A, Krusemark O and Müller J 1998 Numerical simulation and optimization of planar electromagnetic actuators *Sensors & Actuators: A. Physical* **70** 276–282
- [15] Beyzavi A and Nguyen NT 2007 Modeling and optimization of planar microcoils *J. Micromech. Microeng* **18** 095018
- [16] Lee CS, Lee H and Westervelt RM 2001 Microelectromagnets for the control of magnetic nanoparticles *Applied Physics Letters* **79** 3308
- [17] Ahn CH, Allen MG, Trimmer W, Jun YN and Erramilli S 1996 A fully integrated micromachined magnetic particle separator *Journal of Microelectromechanical Systems* **5** 151–158
- [18] Melikhov Y, Lee SJ, Jiles DC, Schmidt DH, Porter MD and Shinar R 2003 Microelectromagnetic ferrofluid-based actuator *Journal of Applied Physics* **93** 8438–8440
- [19] Ramadan Q, Samper V, Poenar D and Yu C 2005 Evaluation of Current-Carrying Wires for Manipulation of Magnetic Micro/Nanoparticles for Biomedical Applications *World scientific* **4** 489

- [20] Lee H, Liu Y, Ham D and Westervelt RM 2007 Integrated cell manipulation system-CMOS/microfluidic hybrid *Lab on a Chip* **7** 331–337
- [21] Rida A, Fernandez V and Gijs MAM 2003 Long-range transport of magnetic microbeads using simple planar coils placed in a uniform magnetostatic field *Applied Physics Letters* **83** 2396
- [22] Nguyen NT, Ng KM and Huang X 2006 Manipulation of ferrofluid droplets using planar coils *Applied Physics Letters* **89** 052509
- [23] Nguyen NT, Beyzavi A, Ng KM and Huang XY 2006 Kinematics and deformation of ferrofluid droplets under magnetic actuation *Microfluid nanofluid* **5** 571–579
- [24] Beyzavi A, Nguyen NT 2009 One-dimensional actuation of a ferrofluid droplet by planar microcoils *Journal of Physics D, Applied Physics* **42** 015004
- [25] Sun Y, Nguyen NT and Kwok YC 2008 High-throughput polymerase chain reaction in parallel circular loops using magnetic actuation *Analytical Chemistry* **80** 6127–6130
- [26] Pipper J, Zhang Y, Neuzil P and Hsieh TM 2008 Clockwork PCR including sample preparation *Angewandte Chemie - International Edition* **47** 3900–3904